

MRT EASY RANGE

Rotating telehandlers



Handling your world

Founded over 60 years ago by the Braud family, the Manitou Group now operates worldwide. A world leader in all-terrain material handling, the Group designs, manufactures, distributes and services equipment for construction, agriculture and industries.

The Group's product ranges include, all-terrain fixed, rotating and heavy-load telehandlers; all-terrain, semi-industrial and industrial masted forklift trucks; wheel or track skid-steer loaders; access platforms; truck-mounted forklifts; warehousing equipment; and attachments.

Through its iconic brands – Manitou, Gehl and Mustang – and its worldwide network of 2,000 dealers and sales outlets, the Group offers the best solutions to create optimum value for its customers.

With headquarters in France, the Group recorded turnover of 2,1 billion euros in 140 countries in 2019, and employs 4,600 people, all strongly focused on customer satisfaction.

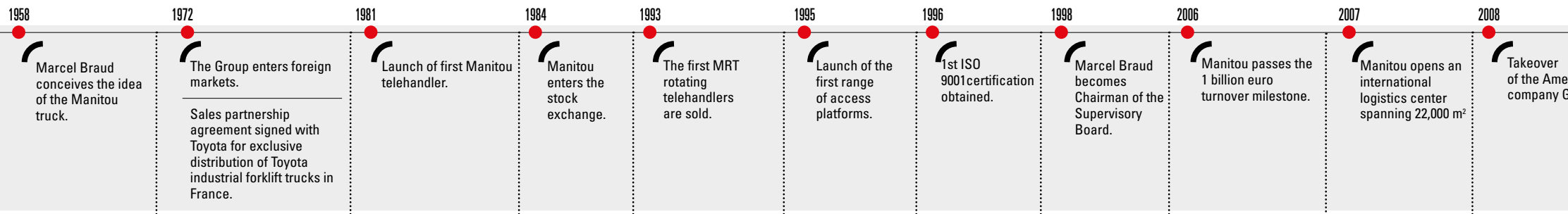

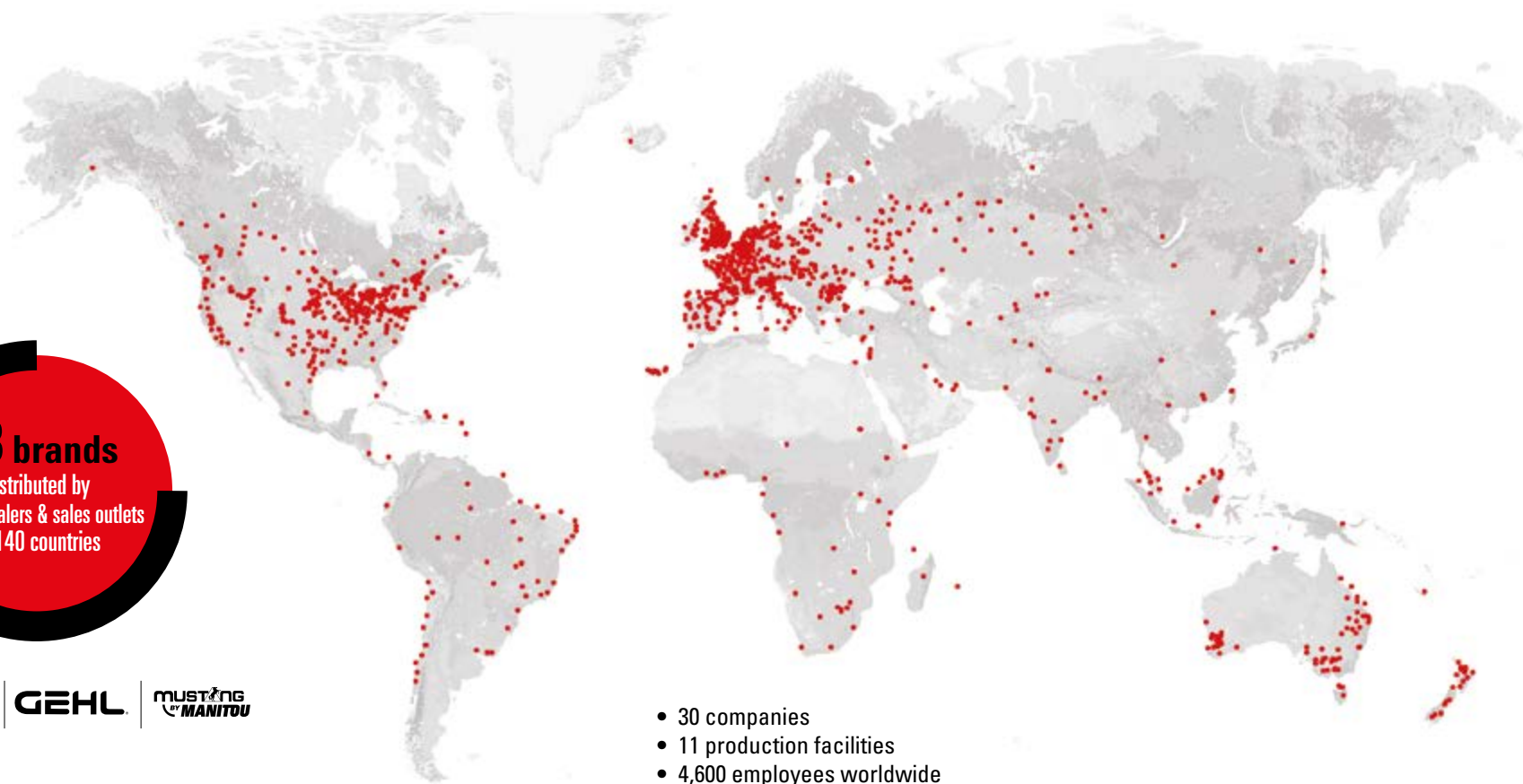

3 brands
distributed by
2,000 dealers & sales outlets
in 140 countries



- 30 companies
- 11 production facilities
- 4,600 employees worldwide
- 64% of the share capital held by the founding families*
- 80% of revenue comes from foreign markets
- 2.1 billion euros of turnover in 2019

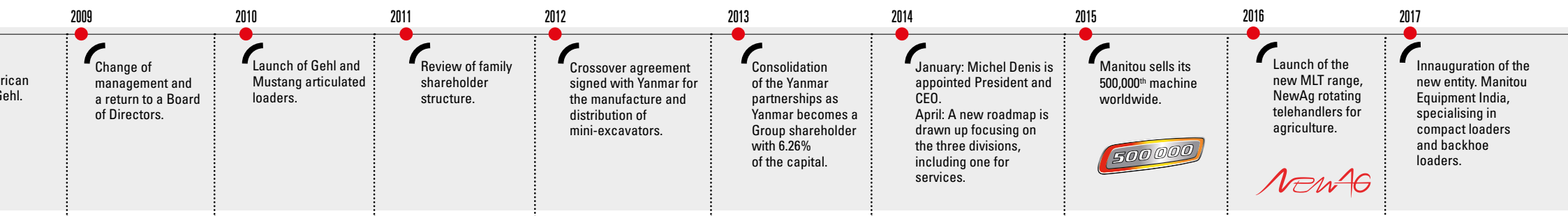

*in 2019



MANITOU



CONTENTS
Rotating
telehandlers

What is an MRT EASY telehandler?	7

Versatile machines	8

Machines that are easy to use	12

High performance machines for all situations	16

Efficient machines	20

Choose the model that is right for you	22

Technical specifications	26

Manitou is here to help	31

Standard equipment and options	33



WHAT IS AN MRT EASY?

The MRT Easy machines are all-terrain telehandlers with 4 wheel drive and steering and 360° or 400° continuous rotation.

The whole range is perfectly adapted for operating quickly and efficiently on all your work sites, maintaining impressive load capacities without the need to move the machine.

Working with an MRT Easy ensures greater profitability for your site with just one machine deployed. Rotation allows you to increase your productivity!

The MRT Easy is the result of Manitou's know-how developed during more than 40 years of experience and innovation on rotating telehandlers.



Marco Lotti,
Manitou Italy
production site manager

//

For 25 years, we have been committed to developing and perfecting the range of rotating telehandlers. These machines are exciting and outstanding in terms of technology and versatility for the benefit of our customers. //

Work easily
up to a height of 25 m

Crowd ram protected under the boom head

Hoses and tubes integrated in the boom for greater protection. Chain boom on MRT Easy 1840, 2145 and 2545 models

Working outreach up to **19.40 m**

Lifting height up to **24.70 m**

Capacity up to **4.5 t**

Cabin line with level II ROPS/ FOPS safety standards: resistant to roll-over and falling objects

Compact one-piece chassis

Lower part of door is glazed. You maintain a good view of the front right-hand part of the machine

Robust axles from reputable brands and steering cylinders in a raised position. Hydrostatic transmission

Short wheelbase for better manoeuvrability

Standard stabilisers (MRT 1440-1640-1840) or spider stabilisers (MRT 2145-2545). Stabiliser cylinders protected inside the structure

MRT EASY		MRT Easy 1440	MRT Easy 1640	MRT Easy 1840	MRT Easy 2145	MRT Easy 2545
Max. capacity	kg	4 000	4 000	4 000	4 500	4 500
Max. lifting height	m	13.80	15.80	17.90	20.60	24.70
Max. outreach	m	11.50	13.50	15.10	17.90	19.40
Type of stabilisers	--	standard	standard	standard	spider	spider
Power Tier 4	hp (kW)	74/55	74/55	74/55	74/55	74/55
Power rating: 3B	hp (kW)	102/75	102/75	102/75	102/75	102/75

From 14 to 25 m
5 models with 360° or 400°



VERSATILE MACHINES

The MRT Easy concept can be used on tyres or stabilisers and combines the capabilities of **3 machines in 1**.

Once the machine is stabilised, **regardless of the position of the turret, you can safely move, lift and handle loads on any site.**

Telehandler mode

- Working on stabilisers or tyres
- **Precise load control**
- Strong pentagonal telescopic boom

Platform mode

- Extendable and adjustable platform with up to **1,000 kg load capacity**
- Up to 36 m working height with a 3D basket (MRT 2545 only)
- Positive and negative work positions (-11 m)

Lifting device **suspended load**

- Winch from **3.0 tonnes to 4.5 tonnes** (models MRT 2145-2545)
- Jib or jib-winch from 600 to 2000 kg





Platform mode

Expand
your work site
applications

Manoeuvre loads through 360° with ease.

Continuous rotation makes your machine more efficient and reduces manoeuvre times.

Regardless of the attachments used, the MRT Easy machines demonstrate excellent manoeuvrability and remain completely stable on the ground.

You can expand your work site applications and manoeuvre loads through 360°.



Telehandler mode

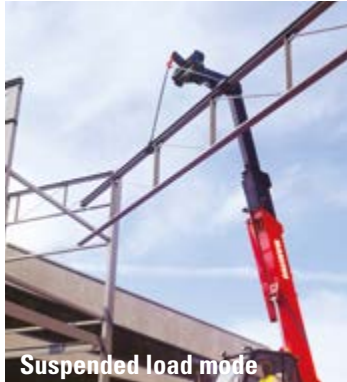

Suspended load mode

Intuitive attachment changing



The MRT Easy range is equipped as standard with an E-RECO attachment recognition system. It detects and analyses the attachment to suggest **the corresponding work envelope and help you to optimise the machine's working parameters.**

Use the radio-control on the ground to work closer to your load

You benefit from excellent visibility over your environment.

The radio-control has a control screen that shows the state of the machine. You can also use it as an operating console when working in platform mode.

All the functions of the boom and its attachments can be handled by the radio-control on the ground or from the place of work.



//
With my radio-control, no matter where I am, I always have a perfect view of the surroundings and the load to be handled! //



David Marchand - Lille
Site supervisor



Radio-control mode



Crab mode

An ultra-manageable range with 3 steering modes

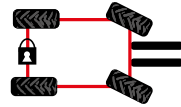

2 STEERING WHEELS

Ensure greater safety on the road.

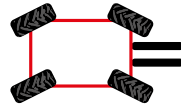

4 STEERING WHEELS

You can manoeuvre easily around cramped sites.

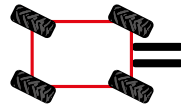

CRAB MODE

You can control tricky sideways approaches.



4 wheel steering mode



2 wheel steering mode



MACHINES THAT ARE EASY TO USE

Monitor
and control

Dashboard all machine functions are centralised

The seven-inch TFT screen is positioned to the right to make it easier to read the information in the driver's cab.

The screen contains just a few menus so that they are easier to remember.

Driver assistance messages are always available on the screen.



Driving

A single screen allows you to monitor all the information related to driving on the road or on site.

- Travel speed
- Steering modes
- General engine information



Speed

Configure the maximum speeds for all machine movements.

- Four stored settings available
- Independent settings for each movement
- Option to amend the settings while the machine is in use



The cabin contains proportional joysticks to simultaneously control all machine movements, including transmission with the integrated FNR (front/neutral/rear) on the right-hand joystick. Each joystick comes with an acceptance button. All movements are completely under control.

In case of incorrect operation of the machine, a message will appear automatically at the bottom of the screen.
You can then immediately correct your error!

- Telescope extension
- Turret rotation
- Attachment controls
- Lifting of the load
- Fork angling
- Reversing shift



Work

Use this screen to view all the machine stability and safety data.

- Stabiliser information
- Load positioning and stability
- Reminder of machine slowdown settings
- You can also restrict the work areas

Additional information

All screens will display stability data (upper section) as well as error codes and alarms (lower section).



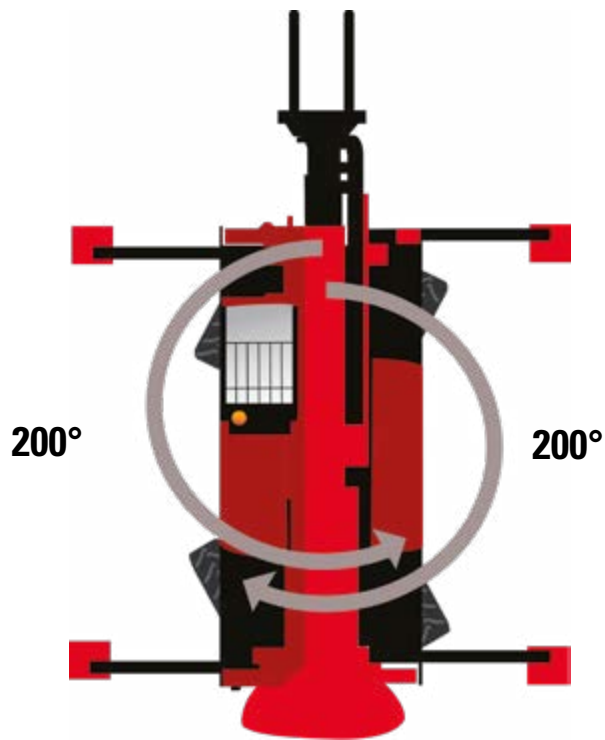

400° version

The MRT Easy 400° version can make a 200° turret rotation on either side of the front position.

You can reach all the areas around your machine.



360° version

With the 360° or continuous rotation version, there is no need to worry about the rotation limit position.

The machine can rotate continuously, **improving your work efficiency and profitability.**



You benefit 100% from the machine's capacities



Stabilisers are deployed rapidly on all models

You benefit from all the Manitou technology to ensure that your machine has the stabilisation surface required to work safely.

- Rapid deployment of the stabilisers
- Automation of stabilisers on 360° version
- The MRT Easy stabilisers boost load chart capacity.



Manitou patented spider stabilisers

The "spider" type stabilisers specific to this machine are Manitou patented. They provide a ground working area of 23.07 m². This area ensures better stabilisation and more efficient load charts.

Standard stabilisers

The standard stabilisers provide a ground working surface of 15.88 m² and are very quick to position. The MRT Easy stabilisers stay in the machine's frame in a closed position (regardless of the type of stabiliser).



HIGH PERFORMANCE MACHINES FOR ALL SITUATIONS

The MRT machines have been designed to adapt to all situations. The hydrostatic transmission, the chassis and the engine power give the machine all the work performance and precision required on all types of terrain.

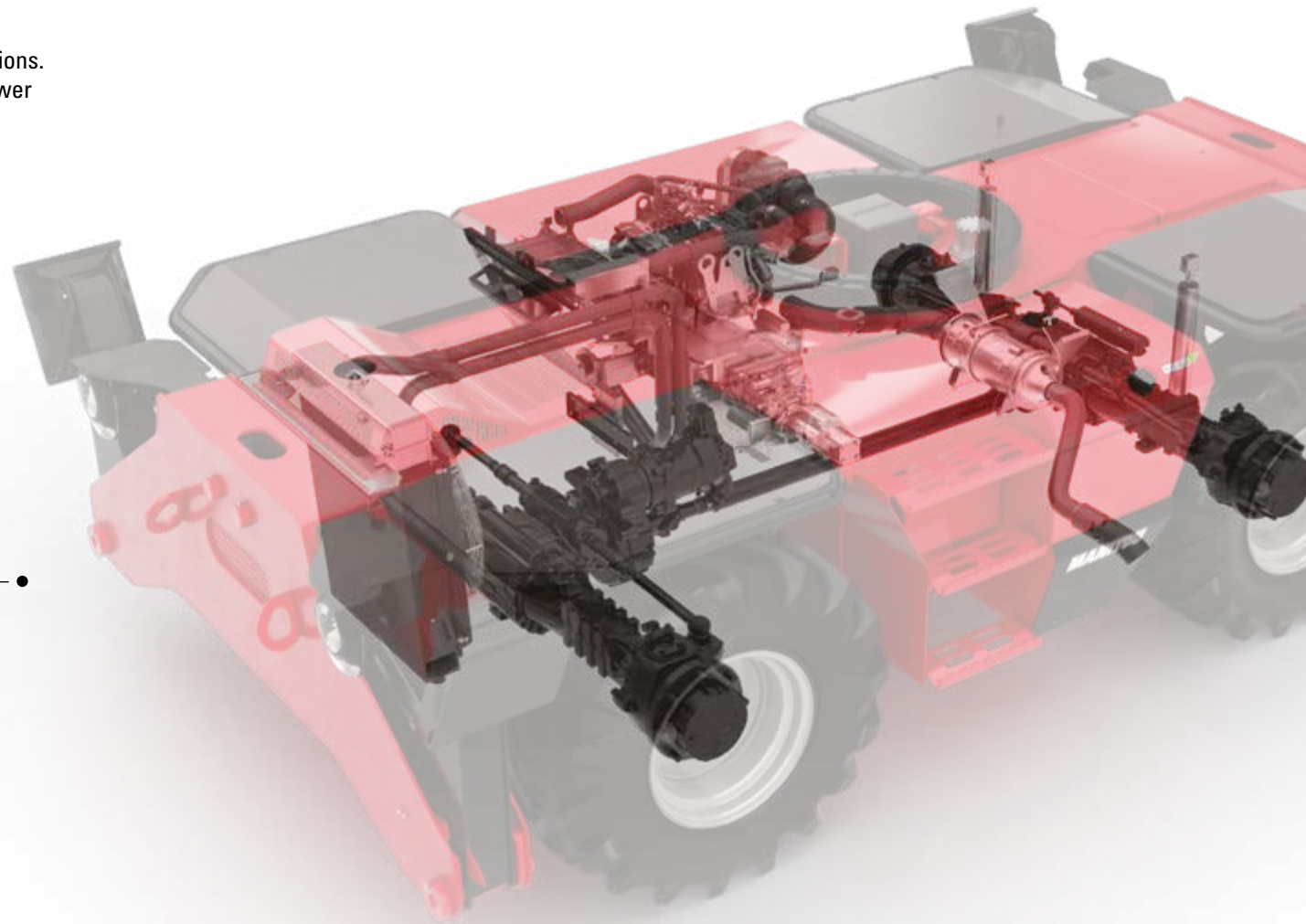

The axles with integrated disc brakes and epicyclic reduction gears **provide all the necessary power for the transmission.**

Both types of MRT Easy chassis provide maximum resistance, thanks to their tubular frames.

The chassis is really the backbone of your machine, preserving its rigidity regardless of position.

**Stabilised
machine**

=

**Turret is
secure**

The hydrostatic transmission ensures maximum flexibility and ease of operation. Combined with a two-speed gearbox, it enables you to adapt your movement speed to the tractive effort. **It allows precise, progressive operation, enabling you to move and position your loads in complete safety.**

The MRT Easy machines are equipped with the inching function (a slow, smooth approach). **You can control travel speeds, resulting in faster manoeuvres.**

Production unit for MRT ranges in Modena (Italy)

Easy access to the principal engine parts

The engines of our telehandlers are mounted on the right hand side of the chassis.

It is easy to access the principal engine components from ground level.

The fully opening engine case gives you access to all the components.



PERKINS 102 hp engine



Fully opening engine case



Rigid engine case surface



Maintenance
is simplified

Working power and precision

Your MRT EASY telehandler is equipped with a **Perkins 102 hp engine** in line with standards Stage IIIB and 74 hp for Tier 4. **Move your machine rapidly between work areas, whatever the working conditions.**



Tractive power



Travel speed

EFFICIENT MACHINES

The Load Moment Indicator (LMI) continuously analyses the position of the load and working configuration of the machine. The system limits the area of movement according to the attachment and the load handled.

The machine continuously measures the mass of the load and its position to ensure maximum work capacity at every point.

Whether you are positioned on stabilisers or on wheels, in a front-facing or side-facing position, the MRT Easy will operate safely.



Side-on position



Front-on position

Customising your work area

To make handling operations safer on crowded sites, you can restrict the machine's area of movement according to the attachment and the load handled.

Version 400° of the MRT Easy offers the option of limiting the maximum working height. Using the information about the turret angle, the 360° version offers the same limitations as the MRT Privilege + range.



With the 360° version, the MRT Easy has the capacity to restrict the working area to the left and to the right, enabling you to work safely along traffic routes and roads with buildings, without endangering nearby road users.



You can also restrict the working area around the machine without having to worry about your surroundings while using the machine.





Stabilised position



Positioned on the lifting and crowd rams on each chamber, the four pressure sensors continuously measure the hydraulic pressures on each side of the piston. **This information lets you know the mass of the lifted load.**



The sensor measures the lifting angle and the length of the boom elongation. The machine knows the position of the load at all times.



The sensor located at the centre of the turret provides continuous information on the turret's angle relative to the chassis.



These sensors inform the safety system of the position of the stabilisers on the ground. **This allows the machine's operating mode to be specified** (on wheels or on stabilisers)



In the 400° version, the MRT easy has sensors that provide information on the turret's front-facing position.





Various attachments installed on the MRT Easy and Privilege +

Choose the attachments and the model that is right for you!

Whether renting or buying, you can choose from a range of 14 to 25 m forklifts. You can also choose the options and all the attachments suited to your requirements.



A complete range of customised tools

Manitou telehandlers are real tool-carriers, which can easily be fitted with the attachment specifically adapted to your application and approved by Manitou.

Simple and rapid coupling

To save you time, the coupling system for Manitou attachments (TS: simple fork carriage with manual or hydraulic locking), is reliable, quick and easy to use.

You can attach and detach your attachments with ease.



Re-handling bucket (CBR)

Perfect for handling sand, earth or gravel, the CBR bucket can handle material with a density less than or equal to 2,100 kg/cm³.



Fork carriage (PFB)

Tilting fork carriage using ISO forks. Optional backrest and side shift available.



Floating fork carriage (TFF)

This floating fork carriage makes it possible to pick up and handle palletised loads on uneven terrain. Available in different widths and capacities, this carriage is suitable for all applications.



PSE 4400 platform

Fast opening platform: **opens/closes in less than 50 seconds**. Guaranteed safety and maximum efficiency for all your work at height (up to 1,000 kg, including three people). Easy access with three entry points (rail or door depending on the model).



Platform Winch

For panel installation and maintenance of industrial facilities, the platform winch ensures safe elevation of personnel and **also allows suspended loads to be lifted and handled directly from the platform without returning to the ground**. Capacity on winch up to 450 kg, including a maximum of three people.



P Jib

Tubular extension jib, **offering the perfect compromise between front outreach and lightness**. This is the essential tool for placing suspended loads. 1,500 kg capacity with outreach of 3m (600 to 2,000 kg capacities available in the offer).



Hydraulic winch

This winch **enables you to significantly increase your suspended load applications** and the profitability of your investment. The hook block assembly offers greater stability. 3 to 5t capacities available.



Aerial jib 2

Personnel elevation solution suitable for work at heights (+9.3m) and depths (-6.4m). **360° arm rotation**. 200 kg capacity (maximum of two people).



PT extension jib with winch

Extend your outreach while transforming your MRT into a mobile crane with this extension jib with hydraulic winch. **The direct hook assembly offers greater speed** (600 to 2,000 kg capacity and hook block versions available). Hook capacity: 1,500 kg.



3D platform

Personnel elevation solution suitable for work at heights (+11.6m) and depths (-10.4m) **and for performing inspections under bridges using the principal telescopic vertical component, 360° rotation of the secondary arm and a pendular basket.**

Do you have any specific requirements or special applications?

Thanks to the experience and skills of its special business department, Manitou is able to offer customised attachments and machines that meet the most detailed specifications.

Please contact us!

MORE ATTACHMENTS AT:
www.manitou.com



MRT 1440



Technical characteristics	
Max. capacity COG 500 mm	4,000 kg
Max. lifting height	13.80 m
Max. outreach	11.50 m
Maximum capacity at max. outreach	950 Kg
Type of engine	Perkins IIIB / Tier 4
Transmission	Hydrostatic
Overall width	2.40 m
Total width with stab. lowered	3.98 m
Overall height	2.97 m
Total length of the forks carriage	5.35 m
Turning radius (over wheels)	3.60 m
Unladen weight (with forks)	12,830 kg

Rotation on lowered stabilisers
with forks

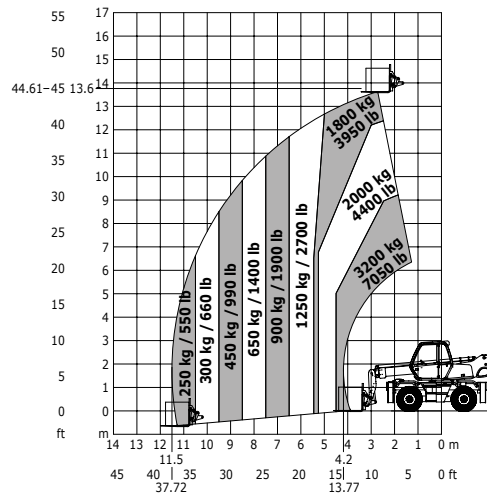

Rotation on lowered stabilisers
with 1500 kg jib

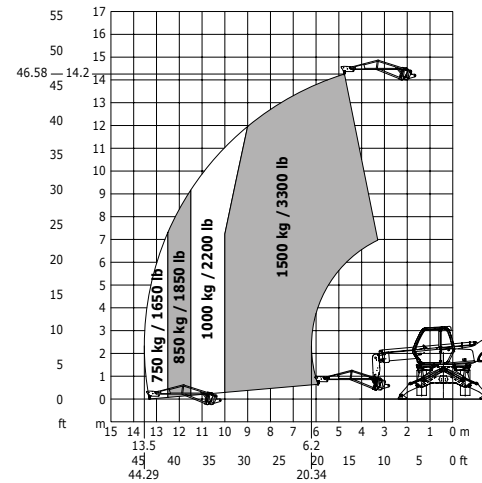

Rotation on lowered stabilisers
with 365 kg platform

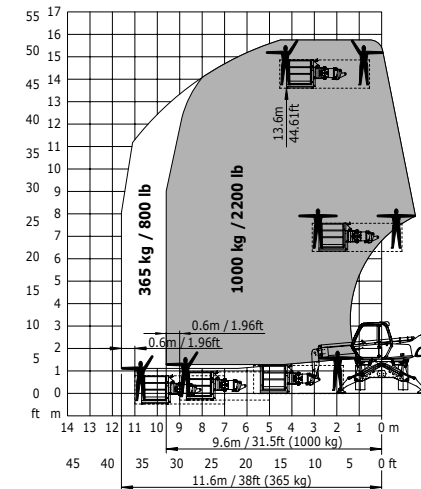



MRT 1640



Technical characteristics	
Max. capacity COG 500 mm	4,000 kg
Max. lifting height	15.80 m
Max. outreach	13.50 m
Maximum capacity at max. outreach	700 Kg
Type of engine	Perkins IIIB / Tier 4
Transmission	Hydrostatic
Overall width	2.40 m
Total width with stab. lowered	3.98 m
Overall height	2.97 m
Total length of the forks carriage	6.36 m
Turning radius (over wheels)	3.60 m
Unladen weight (with forks)	12,880 kg

Rotation on lowered stabilisers
with forks

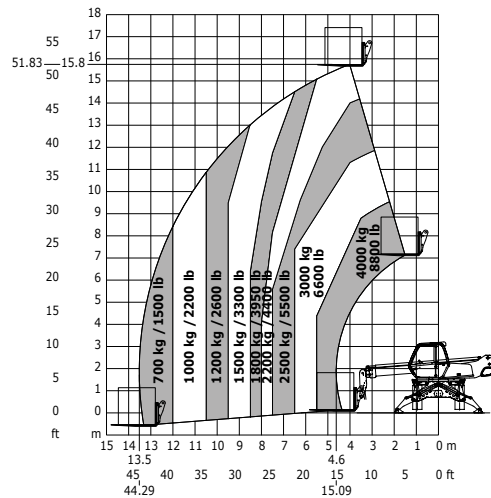

Rotation on lowered stabilisers
with 1500 kg jib

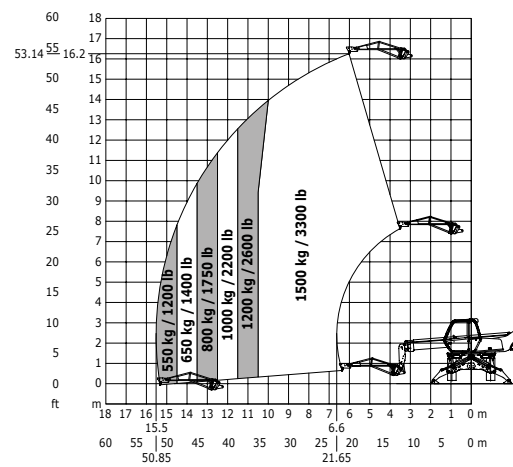

Rotation on lowered stabilisers
with 365 kg platform

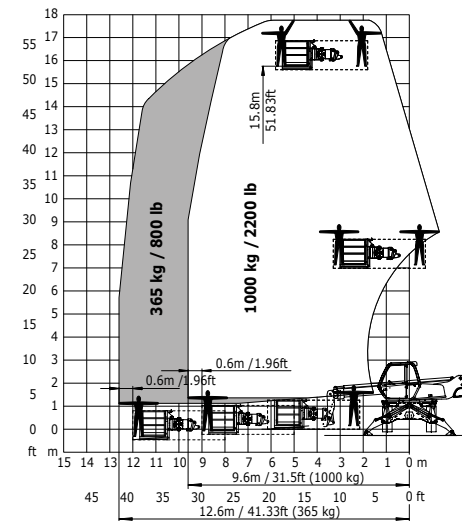



MRT 1840



Technical characteristics	
Max. capacity COG 500 mm	4,000 kg
Max. lifting height	17.90 m
Max. outreach	15.10 m
Maximum capacity at max. outreach	400 kg
Type of engine	Perkins IIIB / Tier 4
Transmission	Hydrostatic
Overall width	2.40 m
Total width with stab. lowered	3.98 m
Overall height	2.97 m
Total length of the forks carriage	5.51 m
Turning radius (over wheels)	3.50 m
Unladen weight (with forks)	13,670 kg

Rotation on lowered stabilisers
with forks

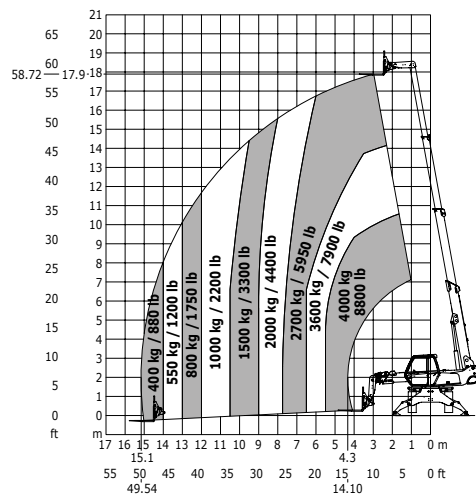

Rotation on lowered stabilisers
with 1500 kg jib

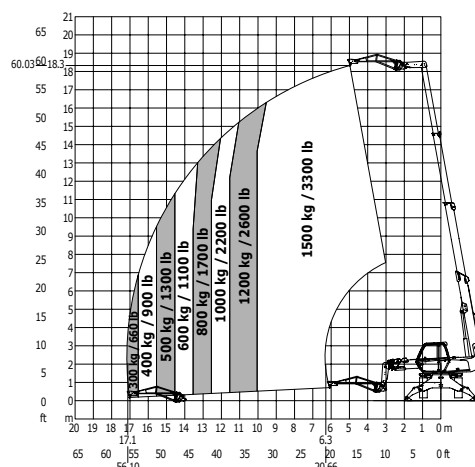

Rotation on lowered stabilisers
with 365 kg platform

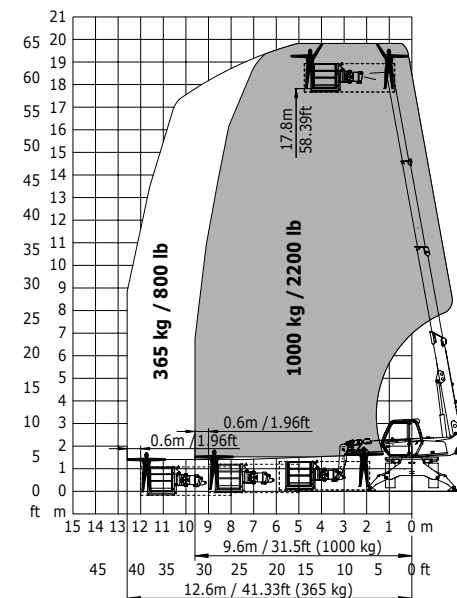



MRT 2145



Technical characteristics	
Max. capacity COG 500 mm	4,500 kg
Max. lifting height	20.60 m
Max. outreach	17.90 m
Maximum capacity at max. outreach	700 Kg
Type of engine	Perkins IIIB / Tier 4
Transmission	Hydrostatic
Overall width	2.48 m
Total width with stab. lowered	4.98 m
Overall height	3.01 m
Total length of the forks carriage	6.59 m
Turning radius (over wheels)	3.60 m
Unladen weight (with forks)	14,530 kg

Rotation on lowered stabilisers
with forks

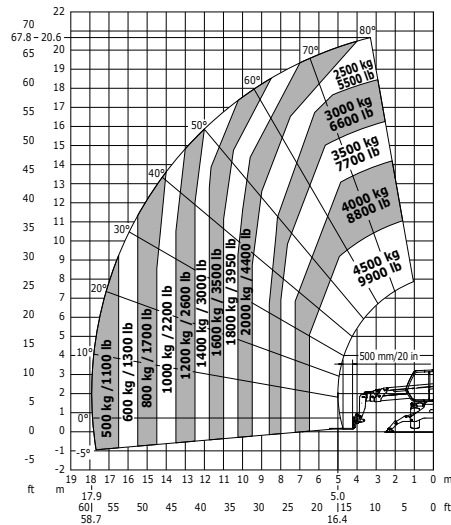

Rotation on lowered stabilisers
with 1500 kg jib

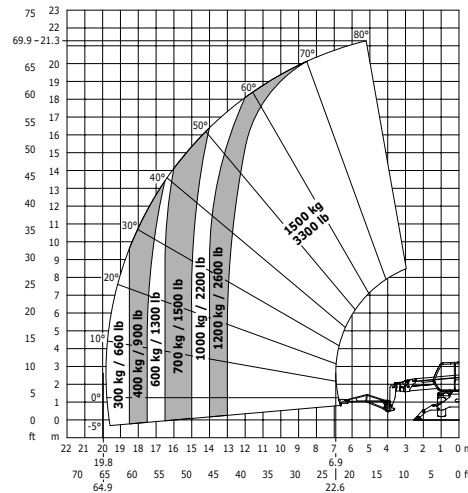

Rotation on lowered stabilisers
with 365 kg platform

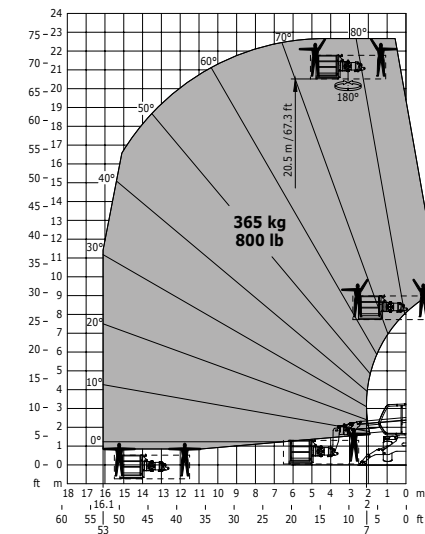

All-terrain load chart Standard
EN 1459 appendix B



MRT 2545



Technical characteristics	
Max. capacity COG 500 mm	4,500 kg
Max. lifting height	24.60 m
Max. outreach	19.40 m
Maximum capacity at max. outreach	200 Kg
Type of engine	Perkins IIIB / Tier 4
Transmission	Hydrostatic
Overall width	2.48 m
Total width with stab. lowered	4.98 m
Overall height	3.01 m
Total length of the forks carriage	7.06 m
Turning radius (over wheels)	3.60 m
Unladen weight (with forks)	15,540 kg

Rotation on lowered stabilisers
with forks

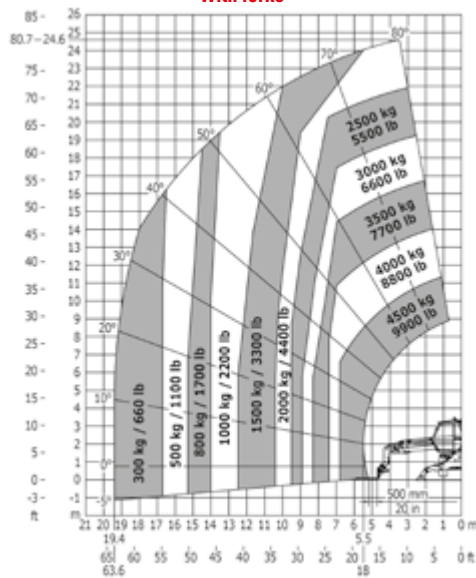

Rotation on lowered stabilisers
with 1500 kg jib

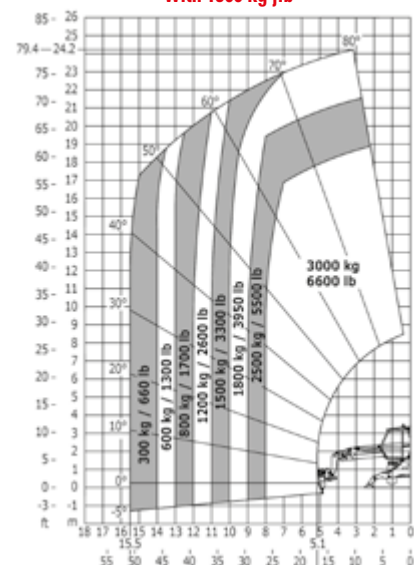

Rotation on lowered stabilisers
with 365 kg platform

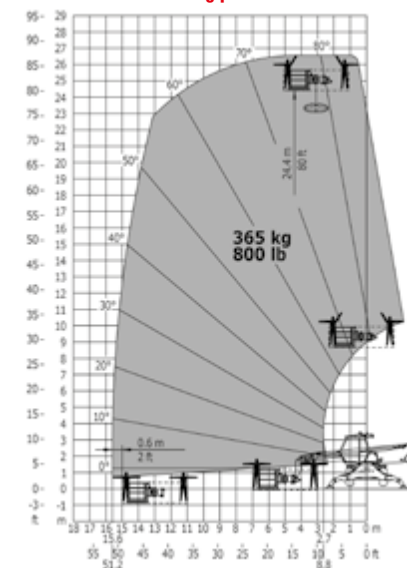

Rough terrain load chart
Standard EN 1459 appendix B

STANDARD EQUIPMENT & OPTIONS

	MRT 14-16-1840 - 400°		MRT 14-16-1840 - 360°		MRT 21-2545 - 400°		MRT 21-2545 - 360°	
	Standard	Option	Standard	Option	Standard	Option	Standard	Option
General								
Battery cut-off	S	--	S	--	S	--	S	--
Internal rear-view mirror	--	0	--	0	--	0	--	0
Roof windscreen wiper	S	--	S	--	S	--	S	--
Automatic levelling	--	0	S	--	--	0	S	--
Working height limitation	S	--	--	--	S	--	--	--
Restriction of work areas	--	--	S	--	--	--	S	--
Reduction in movement speeds	S	--	S	--	S	--	S	--
Extra pads (60 x 60)	--	0	--	0	--	0	--	0
Platform predisposition and radio-control	--	0	--	0	--	0	--	0
Comfort								
Fabric seat	S	--	S	--	S	--	S	--
Air-conditioning	--	0	--	0	--	0	--	0
Pneumatic fabric seat	--	0	--	0	--	0	--	0
MP3 car radio	--	0	--	0	--	0	--	0
Bluetooth radio	--	0	--	0	----	0	--	0
Hydraulics								
Attachment line	S	--	S	--	S	--	S	--
Return to tank	S	--	S	--	S	--	S	--
Dual function on boom head	--	0	--	0	--	0	--	0
Triple function on boom head	--	0	--	0	--	0	--	0
Lock attachment	--	0	--	0	--	0	--	0
Forced walk	--	0	--	0	--	0	--	0
Boom suspension	--	0	--	0	--	0	--	0
Electricity / Security								
E-Reco	S	--	S	--	S	--	S	--
Reverse alarm	S	--	S	--	S	--	S	--
Front work lights	--	0	--	0	--	0	--	0
LED front working lights	--	0	--	0	--	0	--	0
Rear work lights	--	0	--	0	--	0	--	0
LED rear working lights	--	0	--	0	--	0	--	0
Working lights on the boom	--	0	--	0	--	0	--	0
LED working lights on the boom	--	0	--	0	--	0	--	0
Remote control signalling kit	--	0	--	0	--	0	--	0

S: standard / 0: option / --: unavailable







Manitou is here to help

Manitou offers a wide range of products and services that cover all your specific needs to enjoy a high performing machine throughout the year.



Daily expertise and service

Your **Manitou** dealer offers a complete range of services at all stages of your machine's life. The dealer will support you and adapt to your needs in order to provide the best solution to meet your requirements.

1,400 dealers at your service

The Manitou network **operates in more than 140 countries**. In total, we employ more than 2,000 expert technicians, specially trained in Manitou technology, who are at your service to assist with everything from purchasing to after-sales.



- **Dealership network**
 A network of experts at your service, whatever your activity (agriculture, construction, industry).
- **Maintenance contracts**
 We offer three levels of contract to meet your needs: Initial, Advanced and Excellence. Rest easy and leave the maintenance to your official Manitou dealer.
- **Financing**
 Lease or buy? Manitou Finance helps you choose the most suitable financing solution for your activity. Why look any where else?
- **Warranty extension**
 With Maniplus, you can extend the cover of your Manitou warranty for up to 5 years. Use your equipment with peace of mind.
- **The connected solution**
 Easy Manager is a simple and flexible tool for managing, optimizing and securing the operational monitoring of your machines.
- **Second-hand equipment**
 In the market for second-hand equipment? The Manitou network is here to help. Just visit manitou.used.com, our dedicated reference site for second-hand Manitou machines.
- **Original spare parts**
 With more than 70,000 products available, your Manitou dealer offers daily expertise and service!

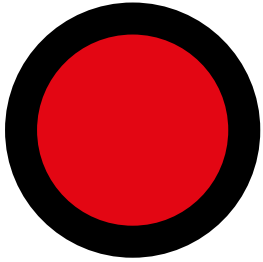

A CONNECTED MACHINE

Easy MANAGER is a simple and flexible tool to maximize the operational monitoring of your equipment. The option is available at the time of order or an after-sales basis.

Management

- See the machine's geographical location and use in real time.
- Increase your machine's availability by allowing your dealer to carry out remote diagnostics.
- Control your budget by ensuring optimum machine maintenance. Maximize the machine's resale value.

Optimization

- Trust the maintenance of your equipment to your dealer, who can access the machine usage data and arrange maintenance operations to suit you.
- Analyze your equipment's performances using the dashboard and activity reports to optimize its use and fuel consumption.

Security

- Protect your equipment against theft and fraudulent use by setting up warnings.
- Control access to your equipment to authenticate users and ensure their safety.

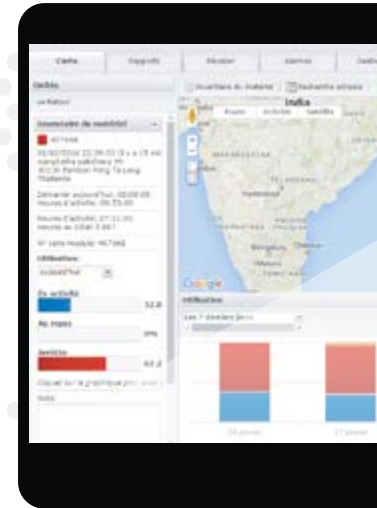

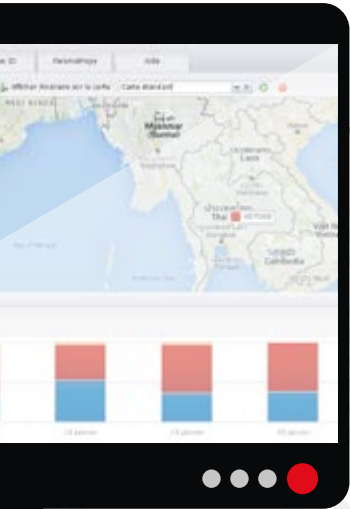

The REDUCE Program

The handling sector does not have a standardized cycle for measuring the fuel consumption of machines. However, the Manitou Group has established an internal protocol which is accessible to everyone and shows Manitou's own consumption measurements (l/h) and CO2 emissions (kg/h) in order to make procedures more reliable, this data

is controlled and approved by an independent organization, the UTAC*, which specializes in approving of vehicles and equipment.

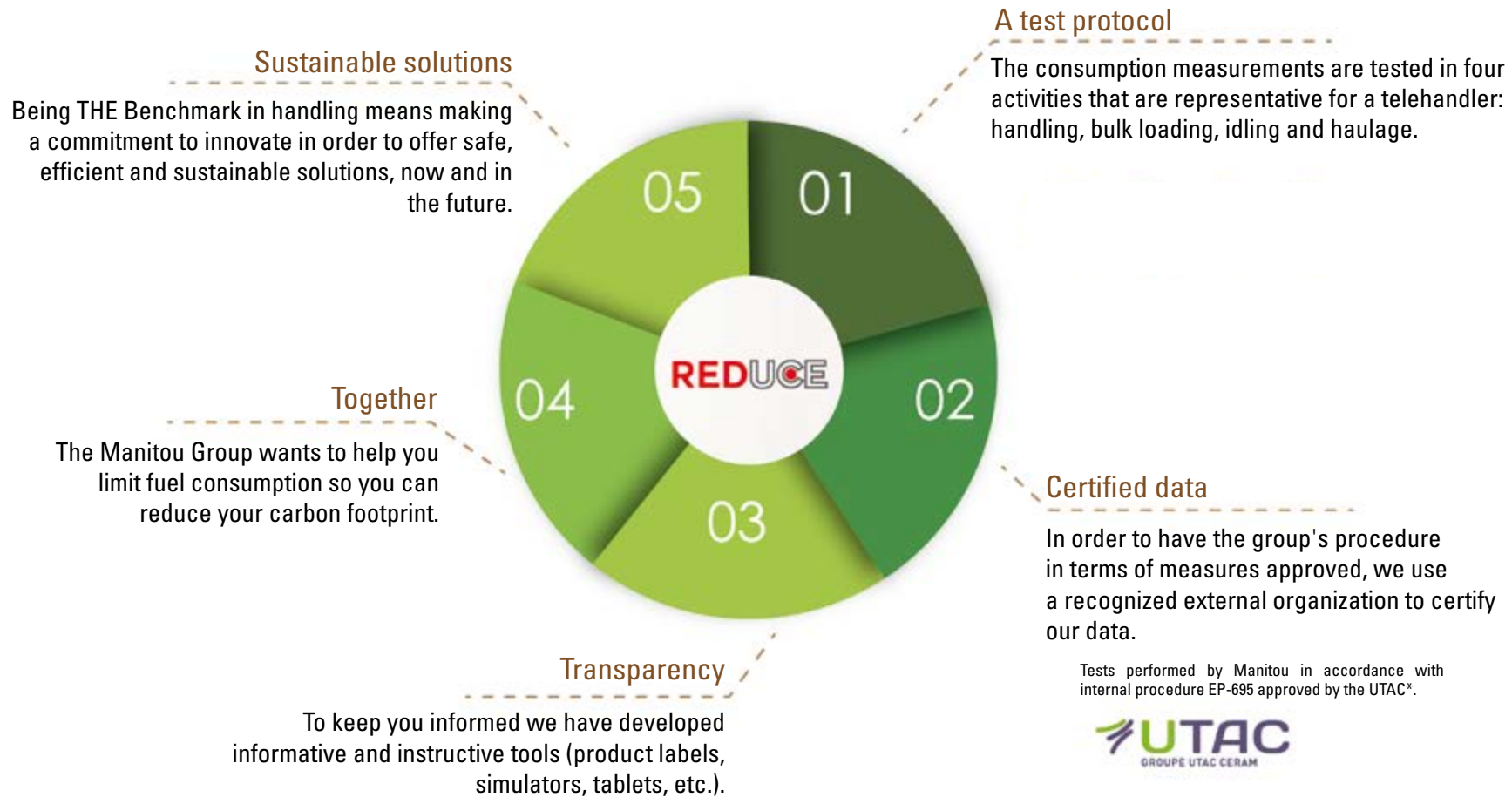

*The UTAC: The Union Technique de l'Automobile du motocycle et du Cycle (UTAC) is the only technical French office to be registered with the European Commission and the UN for vehicle approval.

Here to help

The Manitou Group wants to help you save fuel and reduce the carbon footprint of your machines with these 23 easy-to-follow tips. See more advice at reduce.manitou.com.



Choose the right level of power for your needs.



Switch off your engine after three minutes of idling.



Best engine performance occurs with maximum torque.



Choose controllable and reversible fan systems.



Use 'smart' automated transmissions.



Close doors and windows when using air-conditioning.



Choose LED headlights.



Use the right tires for your environment.



Ensure you have the right tire pressure.



Check that the parking brake is set.

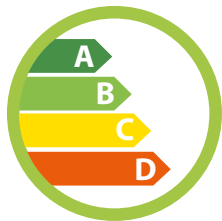

Adjust your maximum trailing load.

Adapt your attachments to your machine.

Respect maintenance schedules.

Ensure regular lubrication.

Make sure you know your machine's fuel consumption and emissions.

Your dealer:



Registered office
B.P. 249 - 430 rue de l'Aubinière - 44158 Ancenis Cedex - France
Tel: +33 (0)2 40 09 10 11 - Fax: 00 33 (0)2 40 09 10 97
www.manitou.com



This publication provides a description of the configuration versions and options for Manitou products, which may differ for equipment. The equipment presented in this brochure may be part of a series, as an option, or it may not be available, depending on the versions. Manitou reserves the right, at any time and without notice, to amend the specifications described and represented. The specifications provided do not bind the manufacturer. For more details, please contact your Manitou agent. This is not a contractually binding document. The presentation of the products is not contractually binding. List of specifications non-exhaustive. The logos as well as the visual identity of the company are owned by Manitou and cannot be used without authorisation. All rights reserved. The photos and diagrams contained in this brochure are only provided for consultation and information purposes.

MANITOU BF SA – Limited company with board of directors – Share capital: 39 547 824 euros - 857 802 508 RCS Nantes